

Specification

Radial Blower U65ML-012KS-5

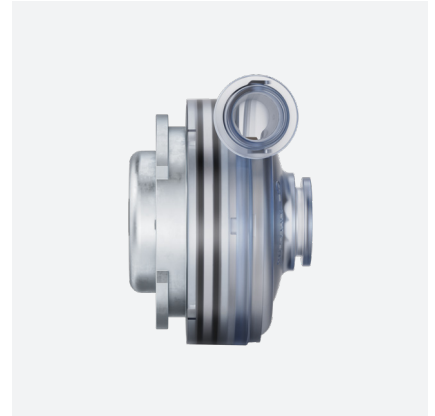
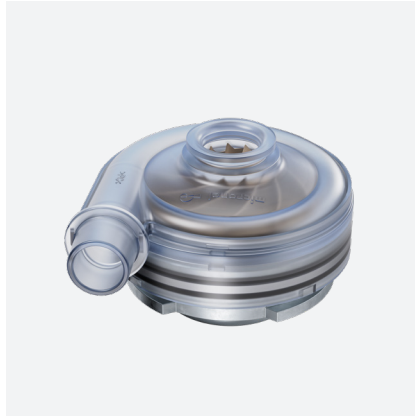

General Information

Item

Product type	Radial blower
Part no.	U65ML-012KS-5
Customer	N/A
Project no.	N/A
Modification	Standard product

Description

This versatile, medical respiration blower has been designed for sleep apnea and homecare applications. It can be operated dynamically, has a very low vibration and noise emission and comprehends a steadily declining pressure/flow curve. U65ML, as well as U65HN and U65MN is a member of the U65 FORM FIT LINE, which provides a uniform pressure and flow behaviour and mounting concept.

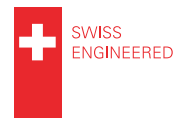

Features

- Static pressure: 36 hPa, freeflow: 260 l/min
- 12 V_{DC} brushless DC-motor
- Highly efficient
- Very quiet operation
- Low inertia rotor



General Conditions

Unless otherwise stated all data are measured at nominal voltage and are valid at 20 °C ambient temperature and 1.2 kg/m³ standard air density. Values listed are nominal and can vary depending on the installation conditions and due to component tolerances. Test setup according to ISO 5801 with standardized inlet and outlet chambers. Tolerances based on specified speed data according to ISO 13348, grade 4: pressure +/-10 %, power +16 %. Tolerances based on constant voltage: speed +/-10 %, pressure +/-21 %, power +33 %. For continuous blower operation please refer to specified maximum ratings. Performance data outside normal operating range plotted for information only.

Performance

Pressure vs. Flow Characteristics

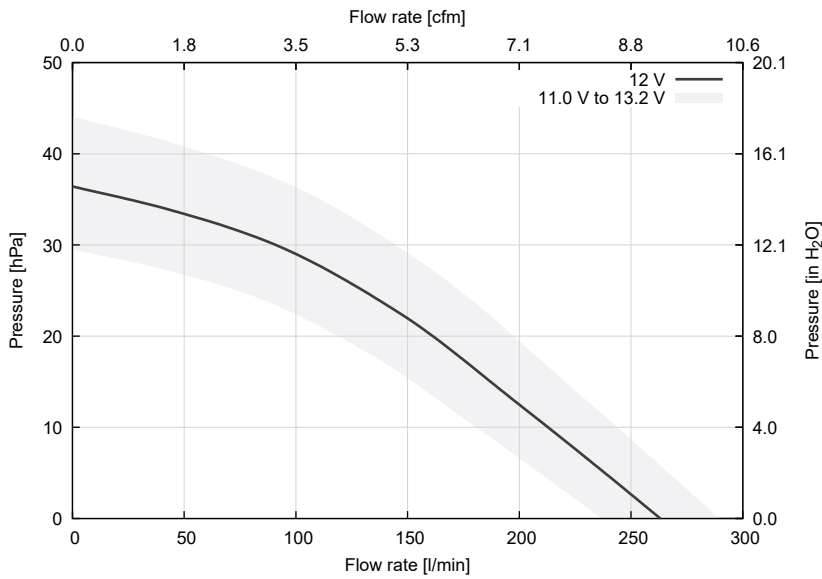

Speed and Power vs. Flow Characteristics

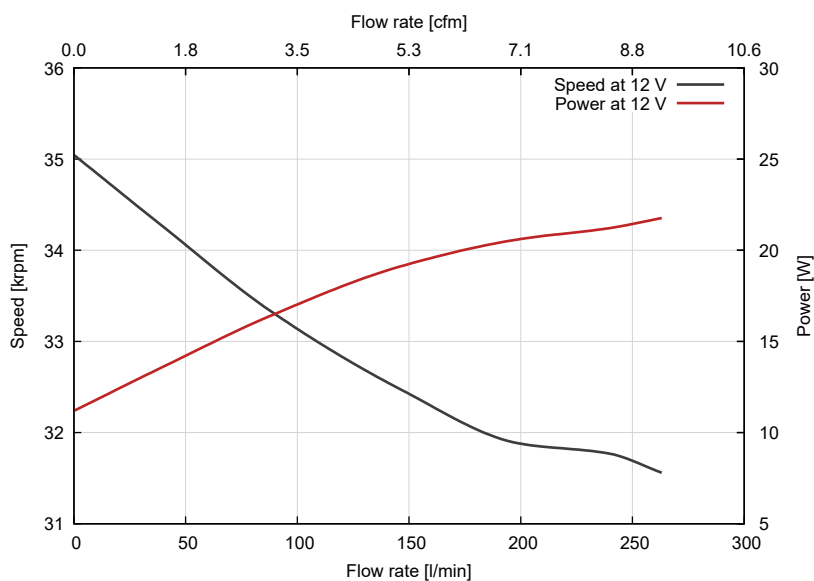

Shut-Off in Pressure Operation (Zero Flow Rate)

	Unit	Value
Static pressure	[hPa]	36
Power consumption	[W]	12
Speed	[rpm]	35000

Shut-Off in Vacuum Operation (Zero Flow Rate)

Static pressure	[hPa]	35
Power consumption	[W]	13
Speed	[rpm]	34850

Free-Air (Zero Static Pressure)

Flow rate	[l/min]	260
Power consumption	[W]	24
Speed	[rpm]	31500

Technical Data

Electrical	Unit	Value
Nominal supply voltage	[V _{dc}]	12
Supply voltage range	[V _{dc}]	11 to 13.2
Maximum Ratings for Continuous Operation		
Minimum flow rate	[l/min]	N/A
Maximum speed	[rpm]	40 000
Maximum acceleration	[rpm/ms]	100
Maximum power consumption	[W]	25
Maximum housing surface temperature	[°C]	70
Maximum NTC temperature	[°C]	N/A
Environmental		
Ambient temperature (operating)	[°C]	-20 to 50
Ambient temperature (storage)	[°C]	-20 to 70
Relative humidity (non-condensing)	[%RH]	10 to 90 (non condensing)
Ingress protection (EN60529)		IP10
Maximum oxygen concentration	[%]	21
Motor		
Type		Brushless direct current motor
Winding insulation class		F, 155 °C
Phase to phase resistance	[Ω]	0.82
Phase to phase inductance	[mH]	0.23
Speed constant	[rpm/V]	2777
Torque constant	[mNm/A]	3.41
Number of pole pairs		1
Hall sensor type		N/A
NTC type		N/A
Lifetime		
L10 at 25 °C ambient temperature ⁽¹⁾	[h]	> 35 000
Acoustics		
Sound pressure level ⁽²⁾	[dB(A)]	47
Leak Tightness		
Maximum leak flow rate	[l/min]	N/A
Mechanical		
Blower weight	[g]	235
Rotor weight	[g]	14.6
Rotor moment of inertia	[g · cm ²]	6.4

⁽¹⁾ Applicable working point: 38 krpm, 25 °C and 40 l/min. Determined under various conditions at normal cleanliness according to ISO 281. Temperature dependency of lifetime according to IPC-9591: factor 1.5 per 10 °C.

⁽²⁾ Measured at distance of 1 meter from inlet, with open inlet, outlet connected to breathing tube and 4 mm orifice in sound cancellation box at 1 kPa.

Drawings

Dimensions in mm

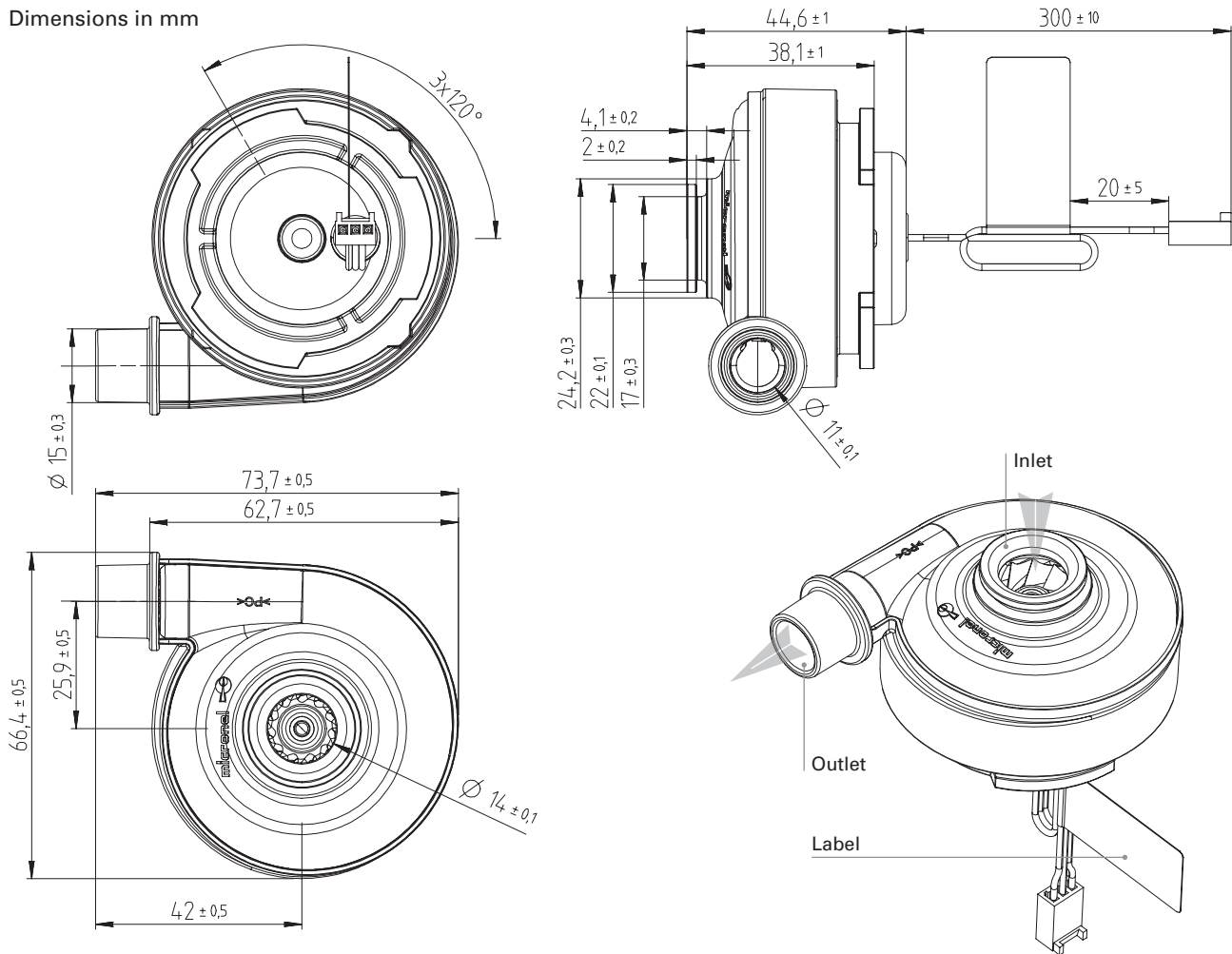

Orientations

Direction of rotation	 Counter-clockwise (view on inlet)
Mounting position	Any direction

Materials

Components	Material
Blower housing	Polycarbonate (PC) Flammability: Glow wire flammability index 850 °C / 1 mm (IEC 60695-2-12) Biocompatibility: USP Class VI / ISO 10993-5
Impeller	PEEK glass fibre reinforced Flammability: Glow wire flammability index 960 °C / 2 mm (IEC 60695-2-12) Biocompatibility: ISO 10993-5
Hub	Brass
Motor housing	Zinc die cast
Label	Plastic
Connector	Molex 22-01-3037
Crimp terminal	Molex 08-50-0032
Lead wire	PVC insulated AWG24 Flammability: UL1061, yellow/red/orange

Identification

Label

Design

Identification number:
 • Year, calendar week (YYWW)
 • Fabrication number (6 digits)
 • Serial number (3 digits)

Part number

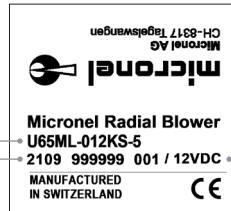

Nominal voltage

Blower pinout

Pin	Color	Description	AWG
1	Orange	Motor Winding 1	24
2	Red	Motor Winding 2	24
3	Yellow	Motor Winding 3	24

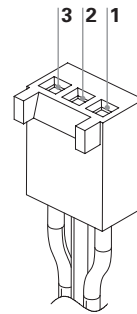

Notice



Handle in power-off conditions only!
 Read operating manual!



Please see separate accessories list or contact
 Micronel Sales for a full list of options and
 accessories.

All data are subject to change without advanced notice.
 © 2024 by Micronel AG. All rights reserved.